



THE QUARTER TURN  
ACTUATOR EXPERTS



CRANE

FL322 034

INTEGRITY  
TESTING  
UNIT

HOLD 1



**LEADING THE WAY IN ACTUATOR DESIGN & MANUFACTURE**

HOLD 1

## Revo – World Class Actuator Technology

The Revo brand is the standard for excellence and performance in actuator technology and is widely recognised in the process industries as a leader in quality and innovation. That innovation is partnered with a manufacturing excellence to drive advances in product technology. With our combined knowledge and experience we can offer the optimum actuator for any application.

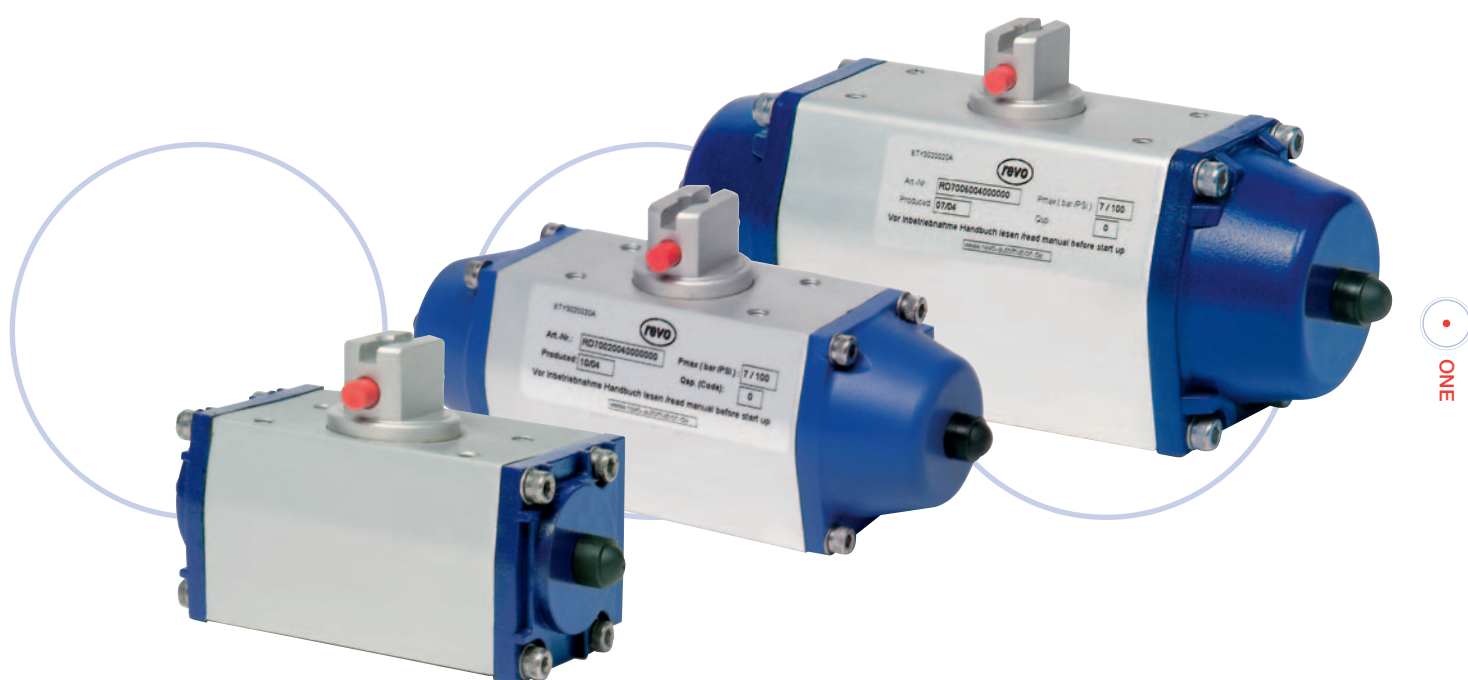

ONE

Revo actuators are primarily used for the operation of valves with 90° travel, such as ball valves, plug valves and butterfly valves, but also find applications where rotary movements of 90°, 180° or others are needed. Revo quarter-turn actuators can be used for open/close applications or for control drive duties.

The range comprises standard models to suit a wide range of torque ratings and flange connections. A comprehensive line-up of specific options further extends the application capability to provide a configuration to suit almost every purpose.

On double-acting versions the valve is opened and closed by the application of compressed air to the actuator. On single-acting actuators compressed air is applied only in one direction, movement in the opposite direction is accomplished by spring force. These drives automatically return to a safe position in the case of a failure in the air supply.

Revo quarter-turn actuators already comply with the EN-standards, which will supersede a large proportion of the DIN-standards, as well as a variety of ISO-standard drafts and various factory standards used in large scale industry.



## A Company with Global Pedigree

As part of Crane Process Flow Technologies, the Revo brand belongs to a wider group that provides solutions to the diversified process industries through the development, production and distribution of actuators, valves, pumps and related flow components.

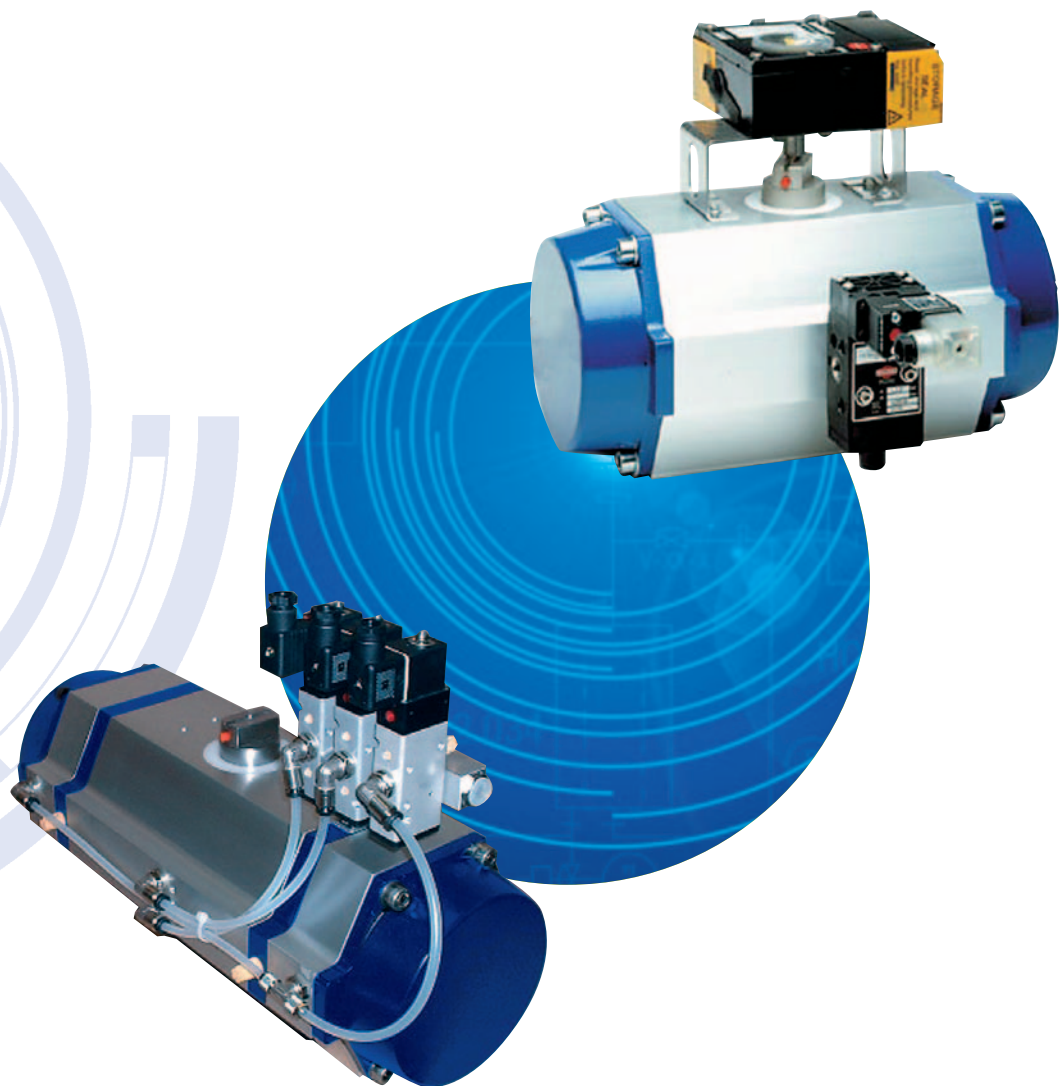

### Experience counts

Crane Process Flow Technologies, in turn, draws upon the heritage and manufacturing experience of the Crane Corporation to provide its customers with a worldwide understanding of manufacturing quality standards and legislative requirements.

This, coupled with a long established network of independent distribution partners, ensures a global network that provides the structure to design and deliver world-class products with world class service.

## Automation

Efficient automation is crucial to the efficiency and profitability of today's processing plants. Whether you're operating basic valve and actuator combinations to facilitate simple "open/close" manoeuvres or running complex bus-interfaced systems as part of wider plant control, there's a Revo actuation package to suit the application.



## Customisation is the Key

No two applications are exactly the same. What matters for your application is that the actuation and control package is fit for the purpose you require. That's why at Revo, we offer a full customisation service. We can supply a single, basic actuator or a complete module consisting of actuation and accessories such as solenoids, limit switches, position and bus-system controls.



## Designed with you in mind

Revo provides solutions, not just products. Flexibility and fast response from initial design, through assembly, test run and inspection of all component parts enables us to provide finished product that meets your expectations. And you can rest assured in the knowledge that our Quality Assurance procedures fully comply with ISO 9001/EN 29001 operational standards.

## Revo Pneumatic Quarter Turn Actuators

Revo pneumatic quarter-turn actuators provide efficient solutions for plant automation tasks. Our unique design features enable continuous trouble-free operation.



Standard connections allow trouble-free installation of accessories such as solenoids, limit switches and positioning devices.

Blow-out safe bushing.  
No external circlips or snap rings to corrode.

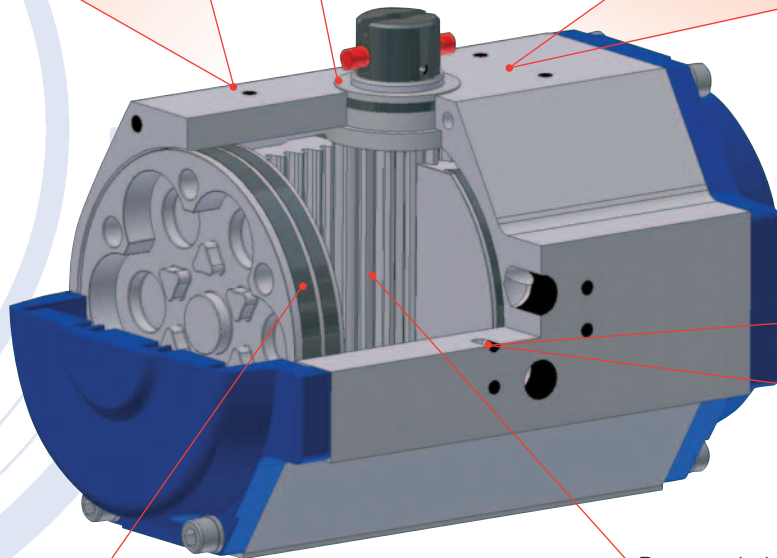
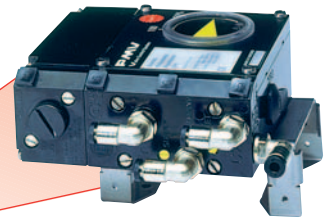

Pressure-balanced,  
blow-out safe pinion.

Sliding bands on spindle,  
arranged with a wide distance  
in between, minimise tilting and  
optimise low-wear operation.



### MAIN APPLICATIONS

- Power plants
- Sugar refining
- Petrochemical processing
- Waste incineration
- Food & Beverage production
- Steel manufacturing
- Pulp & Paper
- Chemical manufacturing

## UNIQUE DESIGN FEATURES

- Patented, pressure balanced spindles prevent axial forces acting on the bearings. This results in high reliability, long lifetime and low wear.
- Spindle and the bearing bushings, mounted from inside, are of blow-out safe design, with no need for external circlips or snap rings, providing high operational safety.
- Robust anodised aluminium housings ensure an even expansion under thermal influences: no jamming of the piston and a high level of corrosion protection.
- Optimally positioned, self-lubricating sliding bands on the piston (made of graphite filled Teflon) ensure low friction operation with minimal risk of piston tilt, resulting in low wear.
- Risk-free and cost saving conversion/ retrofitting of the actuators with left or right wound springs.
- Interfaces comply with NAMUR and ISO-standards.
- Simple retrofitting of accessories, such as solenoid valves, limit switch and positioners.
- Compact design allows extensive direct mounting orientations.

## REVO ACTUATOR OPTIONS

Standard Option.  
Limit Stops for  
012 to 180

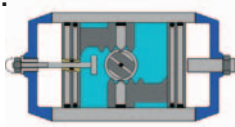

Multi-position  
actuators

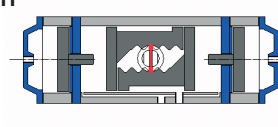

Limit Stop Plates  
for 205 to H15



Hydraulic  
Dampening

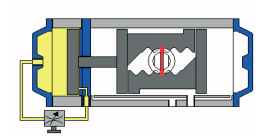

180° Actuator

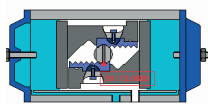
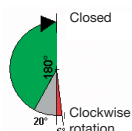

Emergency  
Gears

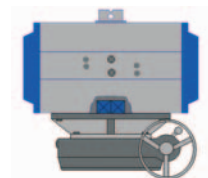

High and Low  
Temperature Options

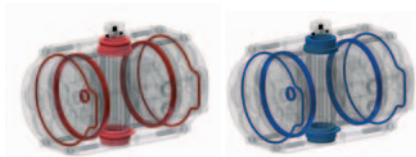

Coatings and  
Special Finishes



# Revo Actuators – Series R

## Torques (Nm)

### Double Acting Actuators

torques are only valid for 0° to 90°

Model	Air Supply (bar)						
	2	3	4	5	6	7	8
RD 001	2.2	3.3	4.4	6.55	6.6	7.7	
RD 002	5	8	11	14	16	19	
RD 006	12	19	25	31	37	43	
RD 012	24	37	49	62	74	86	99
RD 025	48	72	96	120	144	168	192
RD 050	88	133	177	222	266	310	355
RD 090	168	253	337	422	506	590	675
RD 130	256	385	513	642	770	898	1027
RD 180	338	506	675	843	1012	1181	1349
RD 205	506	758	1011	1264	1517	1769	2022
RD 380	758	1138	1517	1897	2276	2655	3035
RD 630	1264	1896	2528	3160	3792	4424	5056
RD 960	1920	2879	3839	4798	5758	6718	7677
RD H15	2938	4407	5876	7345	8814	10283	11752

### Single Acting Actuators

Model	Air Supply (bar)											
	2.5-2.9		3.0-3.9		4.0-4.9		5.0-5.9		6.0-6.9		7.0-10	
	Nm	No of Springs	Nm	No of Springs	Nm	No of Springs	Nm	No of Springs	Nm	No of Springs	Nm	No of Springs
RS/A 002	2	4	2.9	6	3.8	8	4.8	10	5.8	12		
RS/A 006	4.4	4	6.9	6	9.1	8	11.3	10	13.5	12		
RS/A 012	8	4	12	6	16	8	21	10	25	12	29	14
RS/A 025	16	4	44	6	32	8	40	10	48	12	56	14
RS/A 050	29	4	44	6	58	8	73	10	88	12	1020	14
RS/A 090	53	4	80	6	107	8	134	10	160	12	187	14
RS/A 130	81	4	122	6	162	8	203	10	244	12	284	14
RS/A 180	107	4	160	6	213	8	267	10	320	12	373	14
RS/A 205	169	4	253	6	337	8	421	10	506	12	590	14
RS/A 380	253	4	379	6	506	8	632	10	758	12	885	14
RS/A 630	421	4	632	6	843	8	1053	10	1264	12	1475	14
RS/A 960	632	6	948	9	1264	12	1580	15	1896	18		
RS/A H15	979	4	1468	6	1958	8	2447	10	2937	12	3792	14

Other spring combinations possible.



## Flange Connections – DIN/ISO 5211 and female square DIN 3337 Torques (Nm)

Connection	Torque (Nm <sup>1</sup> )	F03 V09	F04 V11	F05 V14	F07 V17	F10 V22	F12 V27	F14 V36	F16 V46	F16 V46	F25 V55	F25 V55	F30 V75
Pinion height		20	20	20	20	30	30	30	30	30	30	30	30
Drilling acc. DIN 3845		25x50	25x50	30x80	30x80 & 30x130	30x130	30x130	30x130	30x130	30x150	30x150	30x175	30x175
<b>Model</b>													
R 001	32												
R 002	32												
R 002	63												
R 006	32												
R 006	63												
R 006	125												
R 012	125												
R 025	125												
R 050	250												
R 090	250												
R 090	500												
R 130	500												
R 130	1000												
R 180	1000												
R 205	2000												
R 380	2000												
R 380*	4000												
R 630	4000												
R 960	4000												
R 960	8000												
R H15	8000												
R H15	16000												

<sup>1</sup> maximum torques for the connection DIN/ISO 5211    \*standard

## Weight & Air Usage

Model	Weight		Air Consumption NL/ travel*
	DA kg	SR kg	
R 001	0.35	0.35	0.06
R 002	0.50	0.50	0.12
R 006	0.95	1.00	0.28
R 012	2.15	2.30	0.53
R 025	3.50	3.80	1.02
R 050	5.85	6.65	1.90
R 090	10.40	12.00	3.60
R 130	19.00	21.00	5.49
R 180	22.50	25.30	7.21
R 205	30.00	33.00	9.00
R 380	37.00	41.50	13.00
R 630	45.00	54.00	22.00
R 960	77.30	89.00	32.50
R H15	92.00	106.00	52.00

\* norm liter at 1 bar per travel 0 - 90°

# Revo Actuators – Series R

## Part Number Configurator

1	2	3	4	5	6	7	8	9	10	11	12	13	14	15
R	D	5	0	1	2	0	0	5	0	M	E	0	0	0



### 1 Series

R Revo Actuator

### 2 Function

D double acting  
 S spring to close  
 A spring to open  
 E 180° actuator, DA  
 F 180° actuator, SR  
 G 180° actuator, SR  
 H hydr.damper, DA  
 K hydr.damper, SR  
 L hydr.damper, SR  
 M multi position 0-45°-90°  
 N multi position 0-90°-180°

### 3 Version

5 90° actuator (012-180)  
 6 90° actuator (012-180)  
 (incl. limit stops open/closed  
 and 4° overtravel)  
 7 90° actuator (001-006)

### 4, 5 + 6 Size

001  
 002  
 006  
 012  
 025  
 :  
 H15

refer to standard  
 data sheets

**INFO**

### 7, 8 + 9 Connection

003 F03, square 9mm  
 004 F04, square 11mm  
 005 F05, square 14mm  
 007 F07, square 17mm  
 010 F10, square 22mm  
 012 F12, square 27mm  
 014 F14, square 36mm  
 016 F16, square 46mm  
 025 F25, square 55mm  
 030 F30, square 75mm

### 10 Number of springs

0 double acting  
 1 single acting, 1 spring  
 2 single acting, 2 springs  
 3 single acting, 3 springs  
 :  
 9 single acting, 9 springs  
 A single acting, 10 springs  
 B single acting, 11 springs  
 C single acting, 12 springs  
 D single acting, 13 springs  
 E single acting, 14 springs  
 :  
 K spring return, 18 springs  
 (only for size 960)

### 11 + 12 Execution

00 standard -20° to 80°C  
 MB High Temperature  
 -17° to 140°C  
 ME Ultra High Temperature  
 -17° to 176°C  
 MC Low Temperature  
 -17° to 176°C  
 MF Ultra Low Temperature  
 -55° to 60°C

### 13 + 14 Coating\*

00 standard  
 (anodized end cap  
 RAL 5002)

\*except 001 – 006, RAL 5009

### 15 Misc.

0 Standard

### INFO – Rule of thumb

size = torques at 1 bar,  
 eg. 012 at 6 bar:  
 12Nm x 6 bar = 72Nm

## Dimensions

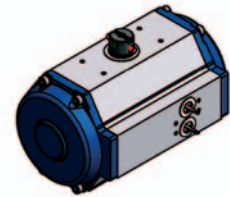
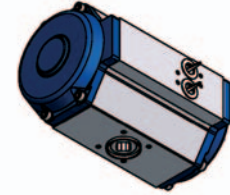
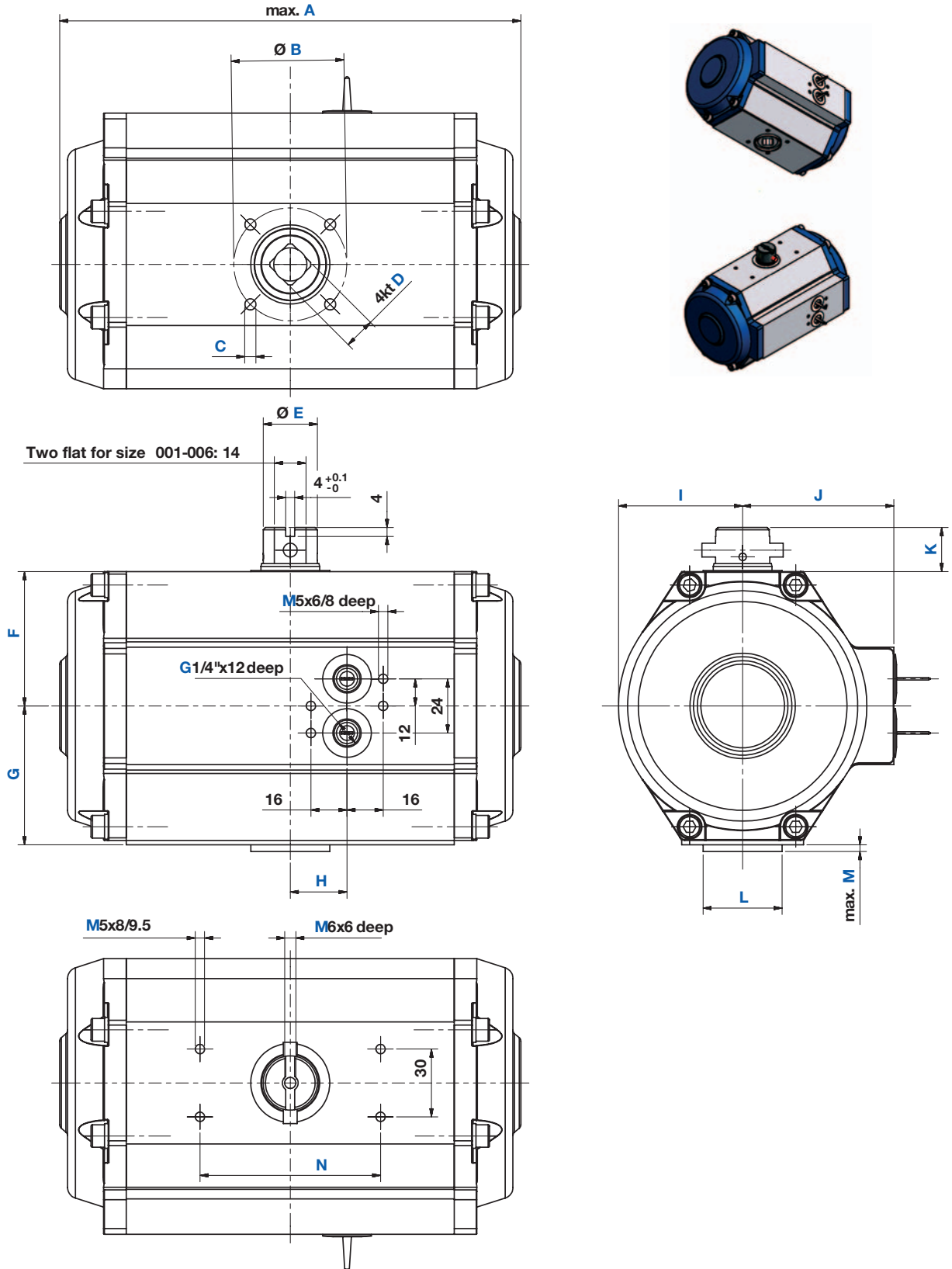

Model

R 001

R 002

R 002

R 006

R 006

R 006

R 012

R 025

R 050

R 090

R 090

R 130

R 130

R 180

R 205

R 380

R 380

R 630

R 630

R 960

R 960

R 960

R 960

R H15

R H15

R H15

R H15

Connection Function		A	B	C	D	E	F	G	H	I	J	K	L	M	N
F03	DA/SR	115	Ø36	(4x) M5x8/10	9H11x10	Ø24	21.0	24±1	-	20.5	30.5±0.5	20±0.5	-	-	50
F03	DA/SR	67	Ø36	(4x) M5x8/9	9H11x10	Ø24	25.5	29±1	-	25.5+0.5	33±0.5	20±0.5	-	-	50
F04	DA/SR	167	Ø42	(4x) M8x12.5/14	11H11x10	Ø24	25.5	29±1	-	67+1	79+1	20±0.5	-	-	50
F03	DA/SR	200	Ø36	(4x) M5x8/9	9H11x10	Ø24	35.5	39±1	-	34±0.5	41±0.5	20±0.5	-	-	80
F04	DA/SR	200	Ø42	(4x) M5x7.5/11	11H11x10	Ø24	35.5	39±1	-	34±0.5	41±0.5	20±0.5	-	-	80
F05	DA/SR	200	Ø50	(4x) M6x10/11	14H11x10	Ø24	35.5	39±1	-	34±0.5	41±0.5	20±0.5	-	-	80
F05	DA/SR	207	Ø50	(4x) M6x8.8/9.8	14H11x17+1	Ø24	44.5+1	46.5+1	25.05	41+1	52.5+1	20-0.5	Ø35	3	80
F05	DA/SR	215	Ø50	(4x) M6x8.8/9.8	14H11x17+1	Ø24	59.5+1	61.5+1	25.15	55+1	67+1	20-0.5	Ø35	3	80
F07	DA/SR	270	Ø70	(4x) M8x12.5/14	17H11x21+1	Ø24	71.5+1	74.5+1	32.25	67+1	79+1	20-0.5	Ø55	3	80(130)
F07	DA/SR	355	Ø70	(4x) M8x13/14.5	17H11x21+1	Ø24	81.5+1	84.5+1	46.85	78+1	94+1	20-0.5	Ø55	3	80(130)
F10	DA/SR	355	Ø102	(4x) M10x16/18.5	22H11x25+1	Ø24	81.5+1	84.5+1	46.85	78+1	94+1	30-0.5	Ø70	4	130
F10	DA/SR	415	Ø102	(4x) M10x16/18.5	22H11x25+1	Ø24	94+1	98+1	54.50	90+1.5	100+1.5	30-0.5	Ø70	4	130
F12	DA/SR	415	Ø125	(4x) M12x18/22	27H11x30+1	Ø24	94+1	98+1	54.50	90+1.5	100+1.5	30-0.5	Ø85	4	130
F12	DA/SR	420	Ø125	(4x) M12x18/22	27H11x30+1	Ø24	106.5+1.5	111.5+1.5	54.50	102+1.5	114+1.5	30-0.5	Ø85	4	130
F14	DA/SR	490	Ø140	(4x) M16x26/27.5	36H11x40+1	Ø53	137+1	137+1	64.50	119+2	135.5+2	30-0.5	Ø100	4	130
F14	DA/SR	600	Ø140	(4x) M16x26/27.5	36H11x40+1	Ø53	137+1	137+1	92.90	119+2	135.5+2	30-0.5	Ø100	4	130
F16	DA/SR	600	Ø165	(4x) M20x30/32	46H11x50+1	Ø53	137+1	137+1	92.90	119+2	135.5+2	30-0.5	Ø130	5	130
F16	SR	740	Ø165	(4x) M20x22/27	46H11x50+1	Ø53	345/2+1	345/2+1	99.00	353/2+1	353/2+1	30-0.5	Ø130	5	130
F16	DA	540	Ø165	(4x) M20x22/27	46H11x50+1	Ø53	345/2+1	345/2+1	99.00	353/2+1	353/2+1	30-0.5	Ø130	5	130
F16	SR	730	Ø165	(4x) M20x25	46H11x50+1	Ø53	420/2+1	420/2+1	96.41	423.5/2+1	423.5/2+1	30-0.5	Ø130	5	150
F16	DA	565	Ø165	(4x) M20x25	46H11x50+1	Ø53	420/2+1	420/2+1	96.41	423.5/2+1	423.5/2+1	30-0.5	Ø130	5	150
F25	SR	730	Ø254	(8x) M16x25	55H11x59+1	Ø53	420/2+1	420/2+1	96.41	423.5/2+1	423.5/2+1	30-0.5	Ø200	5	150
F25	DA	565	Ø254	(8x) M16x25	55H11x59+1	Ø53	420/2+1	420/2+1	96.41	423.5/2+1	423.5/2+1	30-0.5	Ø200	5	150
F25	SR	890	Ø254	(8x) M16x25	55H11x59+1	Ø53	450/2+1	450/2+1	136.00	450/2+1	450/2+1	30-0.5	Ø200	5	175
F25	DA	728	Ø254	(8x) M16x25	55H11x59+1	Ø53	450/2+1	450/2+1	136.00	450/2+1	450/2+1	30-0.5	Ø200	5	175
F30	SR	890	Ø298	(8x) M20x25	75H11x79+1	Ø53	450/2+1	450/2+1	136.00	450/2+1	450/2+1	30-0.5	Ø230	5	175
F30	DA	728	Ø298	(8x) M20x25	75H11x79+1	Ø53	450/2+1	450/2+1	136.00	450/2+1	450/2+1	30-0.5	Ø230	5	175





INTEGRITY  
TESTING  
UNIT

INTEGRITY  
TESTING  
UNIT

HOLD 1

**Crane Process Flow Technologies Ltd**

Grange Road  
Cwmbran  
Gwent NP44 3XX  
UNITED KINGDOM  
Tel: +44 163 348 6666  
Fax: +44 163 348 6777  
www.craneflow.com

**Crane Process Flow Technologies**

6 Alexander Road  
Belfast  
BT6 9HJ  
NORTHERN IRELAND  
Tel: +44 28 9070 4222  
Fax: +44 28 9040 1582  
www.craneflow.com

**Crane Process Flow Technologies s.r.l.**

Via Pusiano 2  
20052 - Monza MI  
ITALY  
Tel: +39 039 2704 280  
Fax: +39 039 2704 450  
www.craneflow.com

**Crane Process Flow Technologies  
India Ltd**

Amar Avinash Corporate Plaza,  
7th Floor, Plot No. D2  
C.T.S. No. 11/1 to 11/4  
Near Inox Multiplex,  
Bund Garden Road,  
Pune 411 001  
INDIA  
Tel: +91 20 26050922 - 26  
Fax: +91 20 26050927  
www.craneflow.com

**Crane Process Flow Technologies GmbH**

Heerdter Lohweg 63-71  
D-40549 Düsseldorf  
GERMANY  
Tel: +49 211 59 56 0  
Fax: +49 211 59 56 111  
www.craneflow.com  
www.revo-automation.de

IZ NÖ Süd, Str. 2/M6  
2355 Wr. Neudorf  
AUSTRIA  
Tel: +43 2236 682-0  
Tel: +43 2236 64353  
www.craneflow.com

**Crane Process Flow Technologies  
SPRL / BV**

Avenue Franklin No. 1  
B-1300 Wavre  
BELGIUM  
Tel: +32 10 8184 44  
Fax: +32 10 8184 58  
www.craneflow.com

**Crane Process Flow Technologies**

Quatro House  
Frimley Road, Camberley  
Surrey GU16 7ER  
UNITED KINGDOM  
Tel: +44 1276 804421  
Fax: +44 1276 804422  
www.craneflow.com

*For sales and technical enquiries originating  
in the UK, please contact Crane Process  
Flow Technologies Ltd in Cwmbran*



Due to constant development and innovation, we reserve the right to make changes to technical specifications as and when required.  
© Copyright 2005 Crane Process Flow Technologies Ltd. All rights reserved.  
Crane® is a registered trademark of Crane Corporation.  
REVO® is a registered trademark of Crane Process Flow Technologies GmbH.

B/REVO/001/05.05/GB

**CRANE**